

Aviation

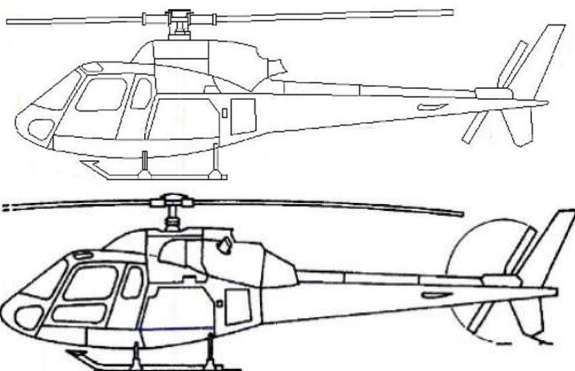
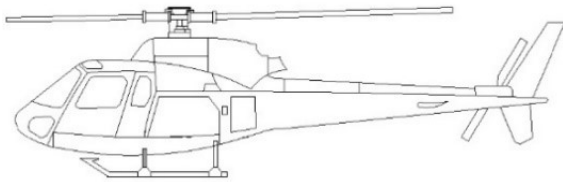

A 109

- Refurbishment of seat cover and carpet

AS 332 L1

- Installation of Removable Sound Proofing System

AS 350

- Refurbishment of Seat Cover, Carpet and Interior
- Installation of Radar Altimeter System
- Installation of Garmin GTN 650 and GMA 340
- Installation of Garmin GNS 430
- Installation of Motorola CM360/ DM1600 Radio
- Installation of Tactical Radio NX-700E
- Relocation of Release Button Cargo Swing
- Installation of Garmin GRA5500 Radar Altimeter
- Installation of ADS-B Traffic sensor
- Installation of GTN 650, Flymap L, TA102 and Avionic Switch
- Installation of Radio Altimeter Warning System
- Installation of Tactical Radio NX-700E and USB Charger
- Installation of Air Traffic Warning System
- Installation of TAS System
- Installation of Digital Heading Indicator
- Installation of Tactical Radio
- Installation of ESI-500
- Installation of Lightning Panels
- Installation of GNC 255, GMA 340 and Kannad 406 AF-Compact
- Installation of USB Charger
- Installation of Kannad ELT
- Installation of Mission Equipment
- Installation of Control and Power Supply for Mission Equipment
- Installation of Electric Digital Attitude Indicator
- Installation of electrical provision for mirror operation

AS 350N

- Installation of automatic deployable ELT (STC)

AS 355

- Installation of Digital Clock/ USB Charger
- Installation of GRA 5500/ GRA55 Radar Altimeter
- Installation of Air Traffic Warning System
- Installation of Kannad ELT
- Installation of Instrument Panel Light
- Installation of Motorola CM360/ DM1600 Tactical Radio
- Installation of Digital Carls BOS Radio

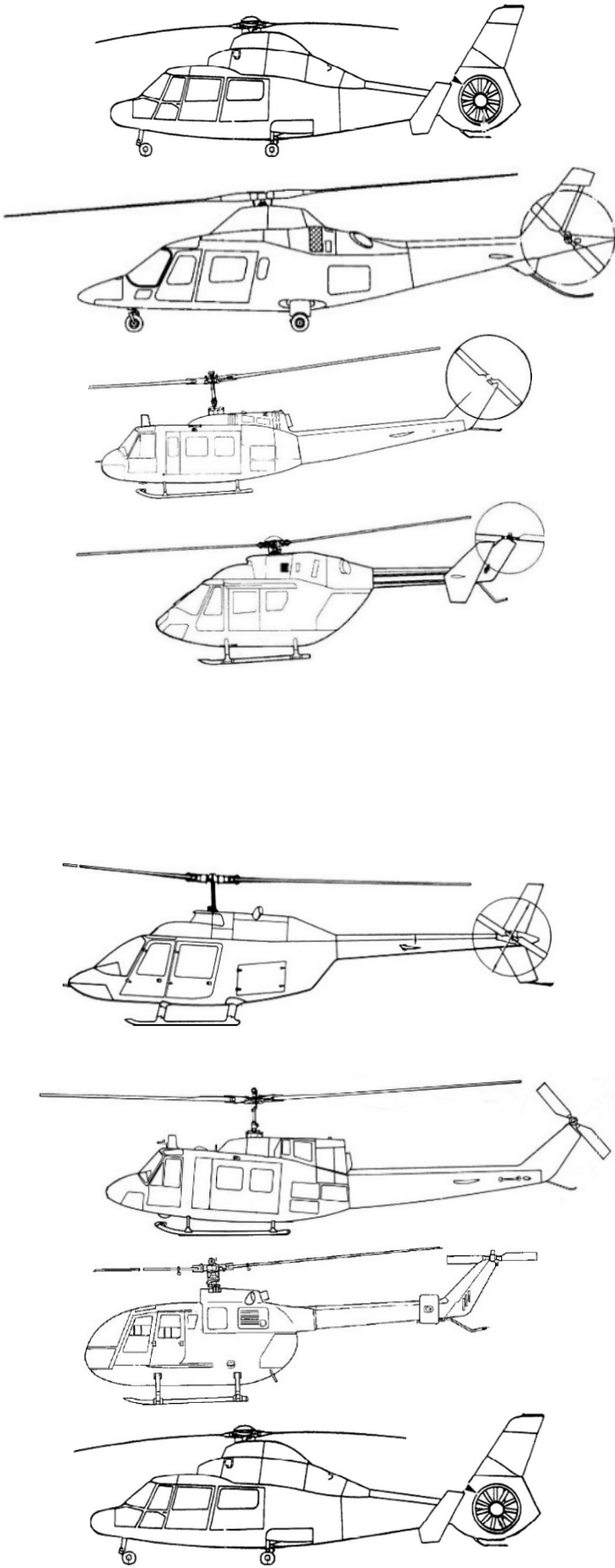

AS 365 N3

- Installation of Adapter Plate for EMS (STC)
- Installation of automatic deployable ELT (STC)
- Installation of Moving Terrain
- Installation of NAT NPX 138 Tact. Radio
- Installation APAREO Cockpit Camera

AW 109

- Refurbishment of seat cover and carpet

Bell 205 A1

- Installation of electrical Power and Control System (STC)

BK 117

- Removal of fixed provisions of tactical system
- Installation of Spidertracks S5
- Refurbishment of Seat Cover
- Installation of Nightscanner (STC)
- Installation of Bendix King KX 165A
- Installation of WLAN Antenna
- Relocation of TAS Antenna and Ground Sensor
- Relocation of ADF Antenna
- Removal of fixed provisions of AMP system
- Installation of Tactical Radios
- Installation of Medical Mount for Hamilton T1
- NVIS Certification of Apple iPhone and Apple iPad and procurement of filter
- Installation of USB Charging Ports

Bell 206

- Installation of KT-73 Transponder
- Installation of Moving Terrain
- Installation of KANNAD 406 AF Compact ELT
- Garmin GNC 255 installation
- Garmin GTX 330 TXP Installation
- KX 165A Installation

Bell 212/412

- Installation of mounting bracket with USB charging port

BO 105

- Installation of Becker AR6201 and Garmin GMA 340H
- Installation of two Garmin G500TXi (H) (VFR Operation) (STC)

EC 365

- Adapter plate for EMS seat installation
- Installation of Digital Carls BOS Radio



EC 135

- Installation of cable duct RH for external mounted hoist system
- Modification of landing gear skid tube RH
- Installation of HEEL System
- Extension of center console
- Installation of Automatic Deployable ELT
- Antenna Installation on Forward Access Cover
- Installation of Dual Trig TY92 COM System
- Cable Deflector installation on Sliding Door RH
- Installation of Medical Racks for Oxylog 3000 and Braun Perfusor Compact
- Installation of TETRA Radio System (NVIS)
- Installation of Tactical Radios
- Installation of automatic deployable ELT (STC)
- Installation of Becker AR6203 VHF Radio
- Refurbishment of Seat Cover
- Installation of Medical Racks for Braun Space Perfusor
- Installation of Cable Deflector Sliding Door RH



EC 155

- Installation of Medical Equipment Retainer (STC)
- Installation of Power Consumption for EMS System
- Installation of TETRA Digital Radio
- Installation of Analog Radio



EC155 B1

- Installation of automatic deployable ELT (STC)
- Installation of Antennas (IFR) (STC)
- Installation of Moving Terrain
- Installation of Ryan 9900BX TAS
- Installation APAREO Cockpit Camera
- Installation of TETRA Radio System
- Installation of AVAD System
- Installation of additional TETRA Slave Unit HBE 767 S
- Installation of Axnes

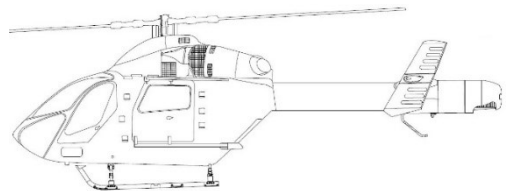

MD 902

- Installation of Tactical Radio
- NVIS Certification of Tactical Radios

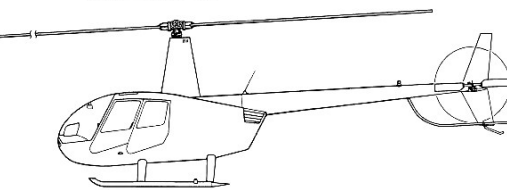

R 44

- Artex ME406 ELT installation
- Installation of antenna retractor

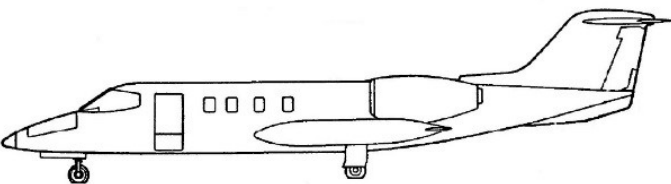

Lear 35A

- Replacement of ISAT-100 with ISAT-200 system

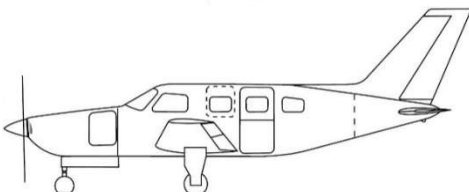

Piper PA 46

- Installation of NY-164 Directional Antenna
- Installation of Iridium Antenna
- Installation of NY-164 Directional Antenna (STC)
- Installation of Iridium Antenna (STC)

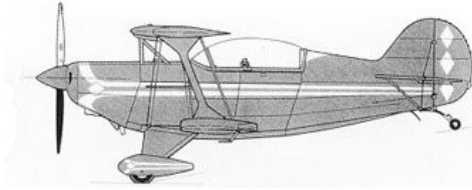

Aviat Pitts S2B

- Installation of Garmin GNC 255A

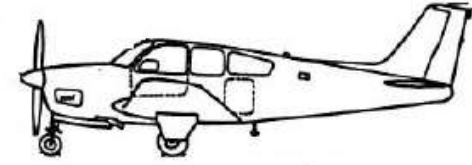

Beech F33A

- Installation of Stromscope WX-500

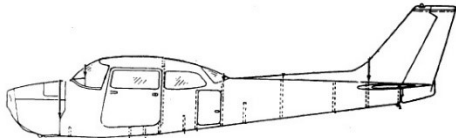

Cessna 172S

- Installation of Funke ATR833A-OLED VHF COM Transceiver

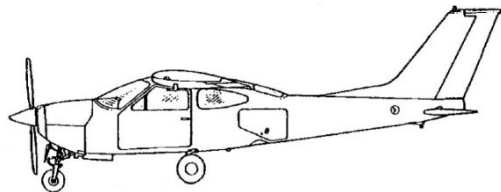

Cessna 177

- Installation of Garmin GNS 430W
- Installations of Garmin GPSMAP 695

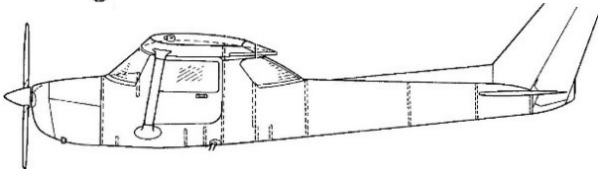

Cessna FRA 150M

- Installation of Funke ATR833A-OLED VHF COM Transceiver

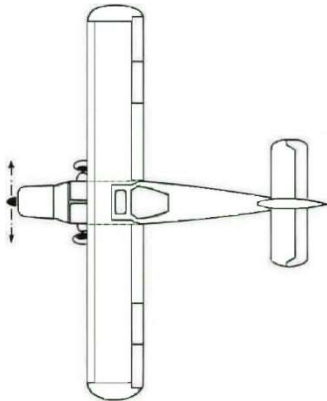

Dornier 27 B1

- Installation of Garmin GTR 225A

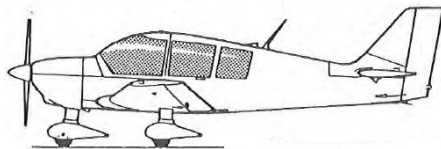

Robin DR 400

- Installation of Becker AR6203 VHF Radio

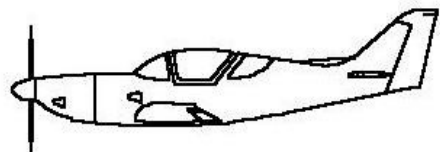

Glasair 2S

- Installation of KRT2-P VHF Transceiver

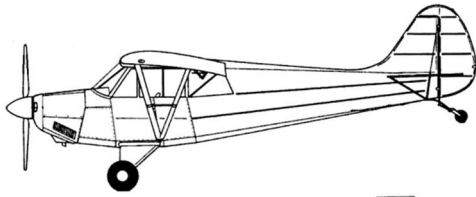

Huskey A-1B

- Installation of GNS 430
- Installation of GNS 431

HORIZONTAL
DASH
NOSE GEAR
TRIM POINT
STA 0

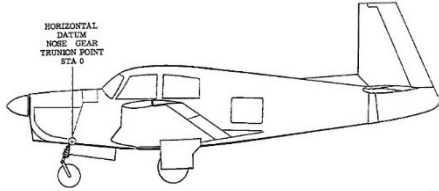

Mooney M20F

- Installation of VHF COM Transceiver KRT-2

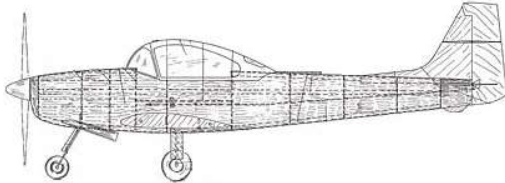

Piaggio FWP-149

- Installation of GNS 530W and Trig TT31

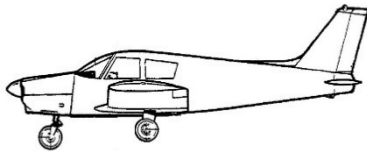

Piper PA 28

- Installation of GMA 345, GTX 330 ADS-B Update, LED Strobe Light and Bose Sockets
- Installation of Funke ATR833A-OLED VHF COM Transceiver



R 22 Beta

- Artex ELT Installation

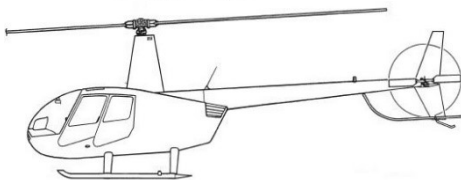

R44

- Installation of GNS 430 (Removal of KY 197, VFR)
- Installation of antenna retractor
- Installation of bracket for Flymap
- Installation of Air Traffic (without external antennas)
- Relocation of GSU 75 ADAHRS

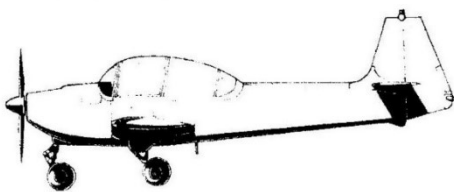

SIAT 223 A1

- Installation of ATR833S CHF Communication Transceiver

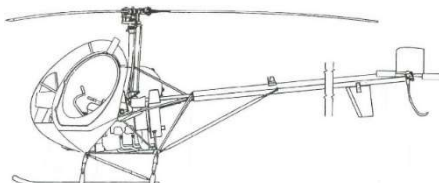

Schweizer 269 C

- Installation of FLARM TRX 2000

Engineering

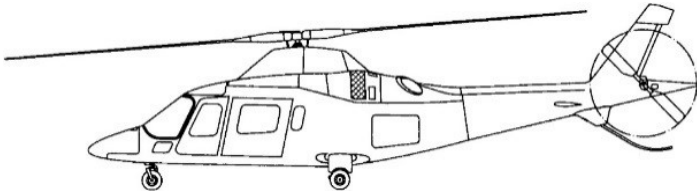

AW 109

- CVE check of fixed provisions



CL 604

- Installation of Passenger Door

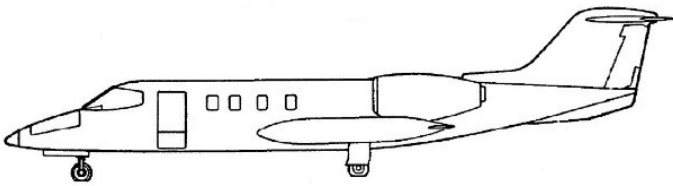

Lear 35A

- Installation of Medical Rack
- Relocation DME
- Installation of ARTEX ELT C406-2
- Relocation of Defog Control Box
- Installation of Universal CVR-120
- UNS-1Lw relocation
- Installation of F-1000 FDR
- 230VAC Inverter installation
- Installation of KTR-909 UHF
- TCAS & TDR Antenna installation
- Installation of GPS Antenna and Doubler
- ELT Antenna and Doubler installation
- Installation of Avionic Console